

ICON 75D DIŐA AÇILIR KAPI SİSTEMİ

A
ALUMİNYUM PROFİL A-01 / A-02

B
CAM MONTAJ TALİMATI B-01 / B-03

C
CONTALAR C-01

D
AKSESUARLAR D-01





E
TAM ÖLÇEKLİ PROFİLLER E-01 / E-05



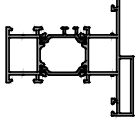
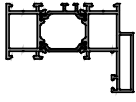
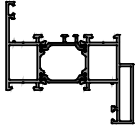
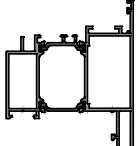
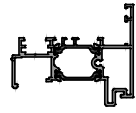

F
PRENSİP SİSTEM DETAYLARI F-01 / F-12

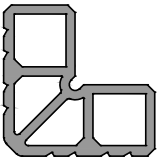
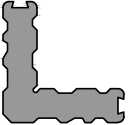
G
FABRİKASYON ve MONTAJ TALİMATLARI G-01 / G-11

ICON 75D DIŐA AÇILIR KAPI SİSTEMİ

ALUMİNYUM PROFİLLER

PROFİL ŞEKLİ	PROFİL ADI	KALIP KODU	PROFİL TANIMI	AGIRLIK
	P 1181	13102 + 13736	ORTAKAYIT PROFİLİ	2,070kg/mt
	P 1182	13102 + 13735	NORMAL KASA PROFİLİ	1,940kg/mt
	P 1183	13734 + 13735	ASİMETRİK KASA PROFİLİ	2,085kg/mt
	P 1184	13738 + 13739	KANAT PROFİLİ	2,385kg/mt
	P 1185	13697 + 13737	ÇİFT KANAT ADAPTÖR PROFİLİ	1,735kg/mt
	P 1186	13740	DIŞ KISIM SABİT CAM ÇITASI	0,260kg/mt
	P 1187	5539	KANAT İÇİN KÖŞE TAKOZ PROFİLİ (P1184 İLE PRES OLARAK KULLANILIR)	8,305kg/mt
	P 1118	5542	KASA İÇİN KÖŞE TAKOZ PROFİLİ (P1173 İLE PRES OLARAK KULLANILIR)	7,282kg/mt
	P 1161	3272	KANAT İÇİN KÖŞE TAKOZ PROFİLİ (P1171 İLE PRES OLARAK KULLANILIR)	6,226kg/mt

PROFİL ŞEKLİ	PROFİL ADI	KALIP KODU	PROFİL TANIMI	AGIRLIK
	P 1176	13698	14mm CAM ÇITASI	0,335kg/mt
	P 1179	13671	18mm CAM ÇITASI	0,350kg/mt
	P 1180	13670	27mm CAM ÇITASI	0,380kg/mt
	P 1105	13113	22mm CAM ÇITASI	0,360kg/mt
	P 1020	12769	TİJ PROFİLİ (ELOXALLI KULLANILIR)	0,105kg/mt

ICON 75D DIŐA AÇILIR KAPI SİSTEMİ

CAM MONTAJ TALİMATI

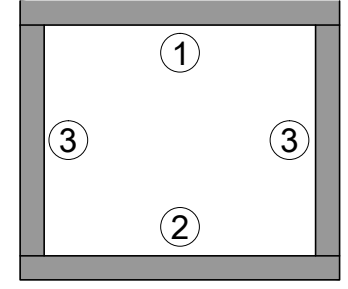
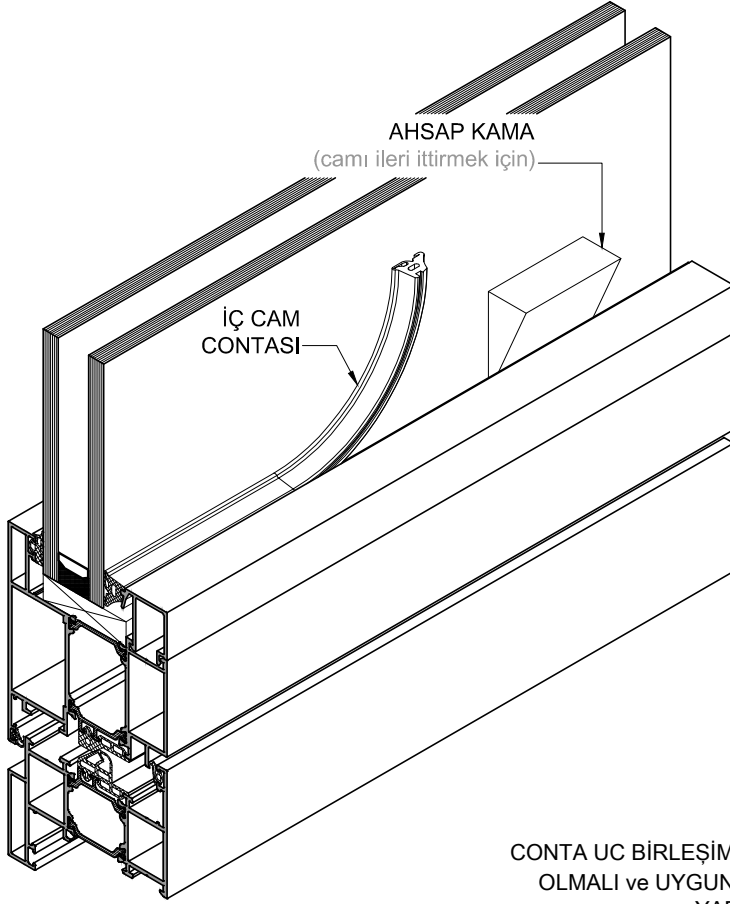

CAM ÇITASI MONTAJ SIRALAMASI

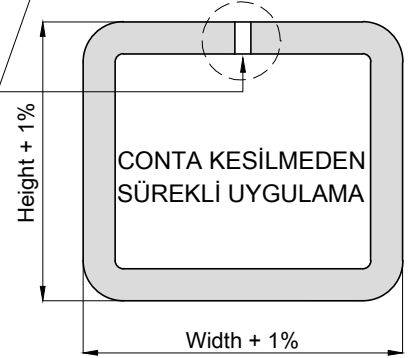
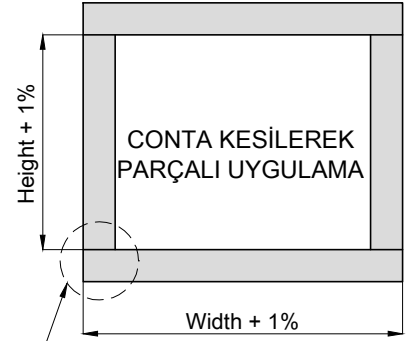

CONTA UC BİRLEŞİMLERİ ÜSTTE
OLMALI ve UYGUN MASTİK İLE
YAPIŞTIRILMALI

CAM TAKOZU

Cam takozları yerleşimi altta bulunan sematik çizimde gösterilmiştir.
takozların kenara mesafeleri kanat ölçüsünün 5/1 i yada 10/1 i kadar olmalıdır.

MESAFE AYARLAMA TAKOZU

Mesafe ayar takozları camın alüminyum çerçeve içinde doğru pozisyonda stabil olarak durmasını sağlar.
cam ile profil arasına takozları zorlamadan yerleştiriniz.

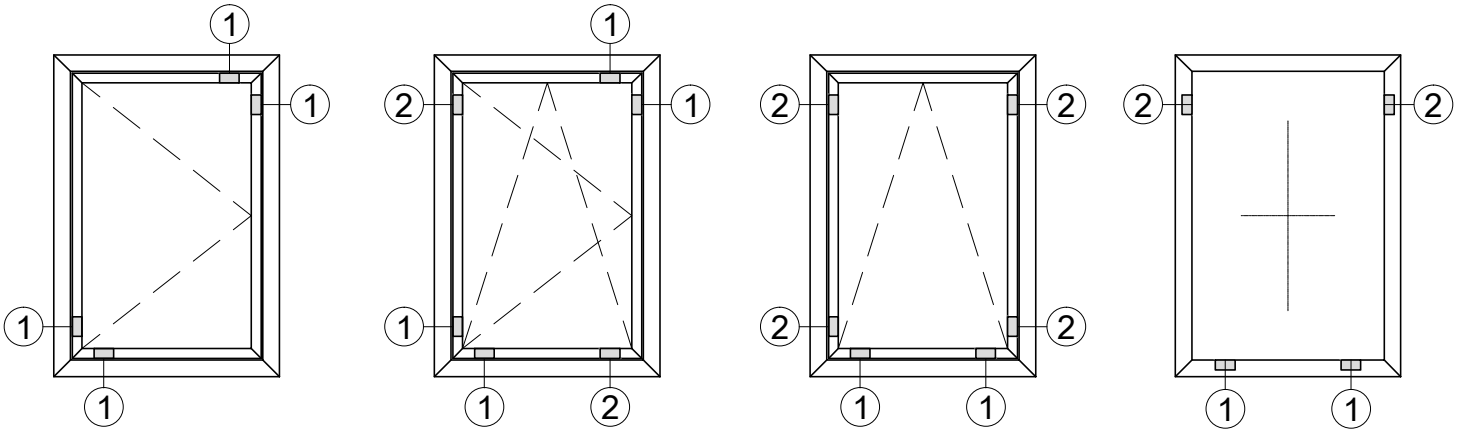

AKSESUAR ve DONANIM MONTAJINDAN ÖNCE TAKOZLAMA
YAPILMALIDIR.

① TAŞIYICI TAKOZ

② AYAR TAKOZU

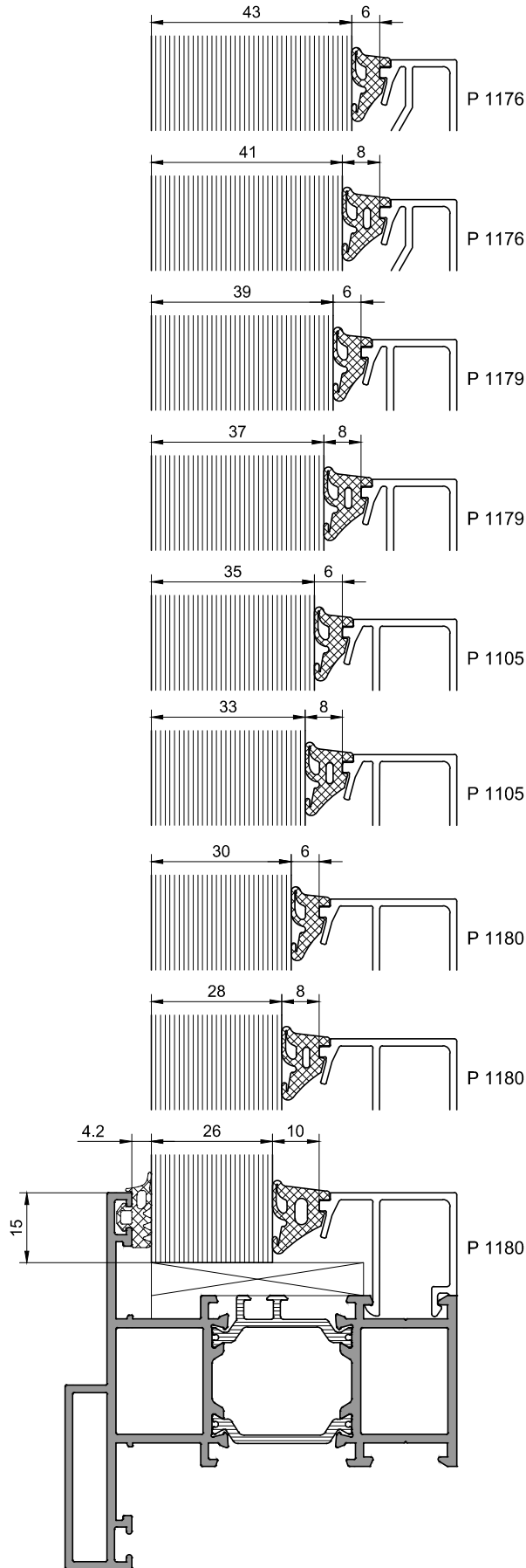

CAM KALINLIĞI	CAM ÇİTASI	İÇ CAM CONTASI	DIŞ CAM CONTASI
26mm	P 1180	800 278 10mm conta	800 218 3mm conta
28mm		800 277 8mm conta	
30mm		800 271 6mm conta	
33mm	P 1105	800 277 8mm conta	
35mm		800 271 6mm conta	
37mm	P 1179	800 277 8mm conta	
39mm		800 271 6mm conta	
41mm	P 1176	800 277 8mm conta	
43mm		800 271 6mm conta	

Yukarıda tablodaki veriler teoriktir.
Lütfen cam ve conta toleranslarını dikkate alınız.

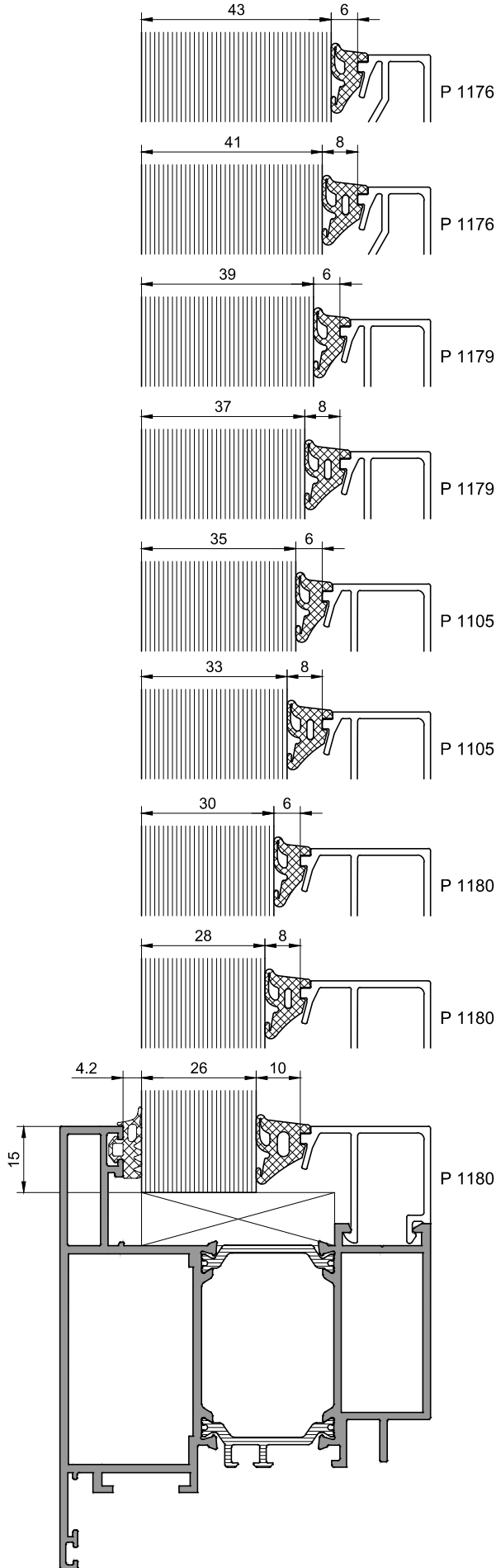







CAM KALINLIĞI	CAM ÇİTASI	İÇ CAM CONTASI	DIŞ CAM CONTASI
26mm	P 1180	800 278 10mm conta	800 218 3mm conta
28mm		800 277 8mm conta	
30mm		800 271 6mm conta	
33mm	P 1105	800 277 8mm conta	
35mm		800 271 6mm conta	
37mm	P 1179	800 277 8mm conta	
39mm		800 271 6mm conta	
41mm	P 1176	800 277 8mm conta	
43mm		800 271 6mm conta	

Yukarıda tablodaki veriler teoriktir.
Lütfen cam ve conta toleranslarını dikkate alınız.

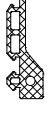
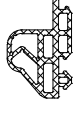

ICON 75D DIŐA AÇILIR KAPI SİSTEMİ

CONTALAR

CONTA ŞEKLİ	CONTA KODU	MALZEME CİNSİ	CONTA TANIMI	PAKET
	800 218	EPDM	DIŞ CAM CONTASI	200mt/paket 0,072kg/mt
	800 274	EPDM	KANAT İÇ BİNİ CONTASI	425mt/paket 0,035kg/mt
	800 275	EPDM	KANAT BİNİ CONTASI	100mt/paket 0,146kg/mt
	800 276	EPDM	KASA BİNİ CONTASI	80mt/paket 0,181kg/mt
	800 232	EPDM	KANAT DIŞ BİNİ CONTASI	230mt/paket 0,033kg/mt
	800 271	EPDM	İÇ CAM CONTASI	185mt/paket 0,081kg/mt
	800 277	EPDM	İÇ CAM CONTASI	165mt/paket 0,092kg/mt
	800 278	EPDM	İÇ CAM CONTASI	115mt/paket 0,130kg/mt

ICON 75D DIŐA AÇILIR KAPI SİSTEMİ

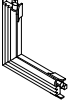
AKSESUARLAR

AKSESUAR ŞEKLİ	AKSESUAR KODU	AKSESUAR TANIMI	MİKTAR
	700 305	DIŞ CAM CONTASI İÇİN KÖŞE VULKANİZE	50adet
	700 322	ALUMİNYUM SIKIŞTIRMALI ONBAŞI (Tüm kasa,kanat profilleri T ve 45° birleşimde kullanılır)	250adet
	700 356	KANAT İÇ BİNİ İÇİN ONBAŞI (0,8mm paslanmaz P1184 ile kullanılır)	500adet
	700 367	ORTA KAYIT T BİRLEŞİM ÖN ve ARKA PARÇASI (P1182 ve P1183 ile kullanılır)	50takım
	700 334	KASA İÇİN PVC ONBAŞI (700 322 ye alternatif sadece kasa iç 45° birleşimde kullanılır)	500adet
	700 335	T KASA İÇİN PVC ONBAŞI (sadece kasa 45° dış birleşimde kullanılır)	500adet
	700 336	SU TAHLİYE KAPAGI	500adet
	700 368	ÇİFT KANAT ADAPTÖR PROFİLİ ALT ve ÜST KAPAGI (P1185 ile kullanılır)	50takım

ICON 75D DIŐA AÇILIR KAPI SİSTEMİ

TAM ÖLÇEKLİ ALUMİNYUM PROFİLLER

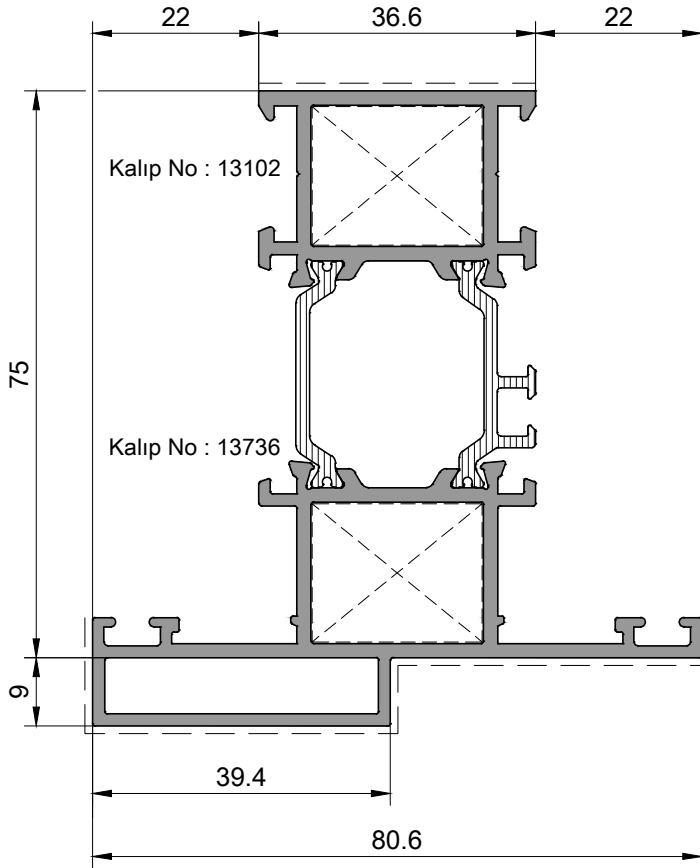

P 1181
Orta Kayıt Profili

Ağırlık : 2,070kg/mt

Ix : 49.98 cm⁴
Iy : 20.99 cm⁴
Wx : 11.65 cm³
Wy : 4.34 cm³

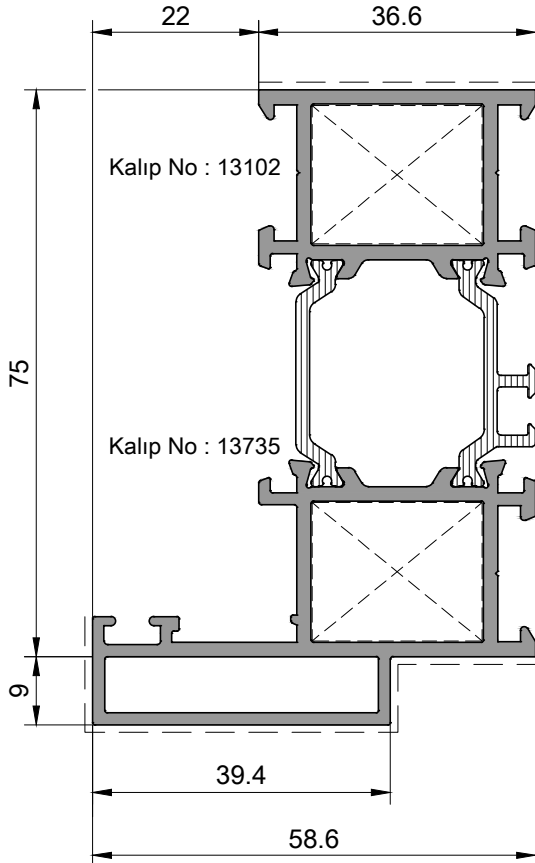

P 1182
Kasa Profili

Ağırlık : 1,940kg/mt

Ix : 48.50 cm⁴
Iy : 12.82 cm⁴
Wx : 13.81 cm³
Wy : 2.76 cm³

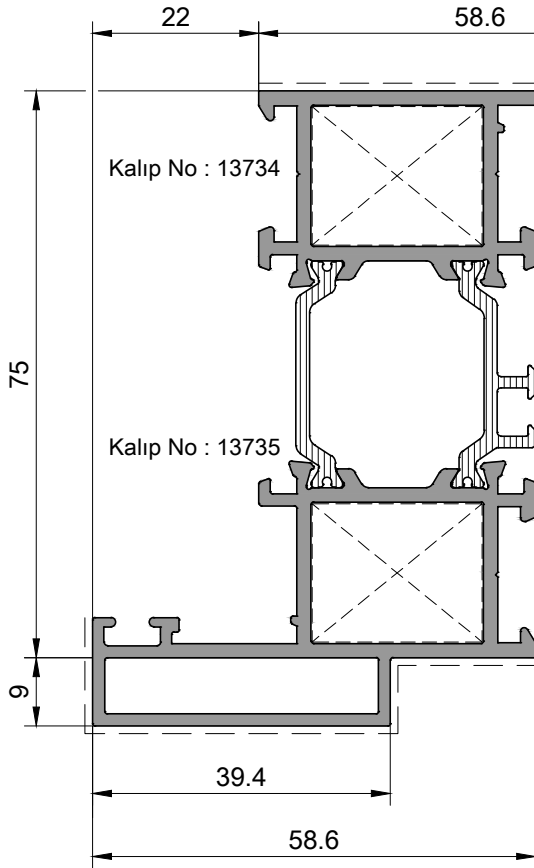

P 1183
Asimetrik Kasa Profili
Ağırlık : 2,085kg/mt

I_x : 60.33 cm⁴
 I_y : 15.12 cm⁴
 W_x : 14.09 cm³
 W_y : 3.51 cm³

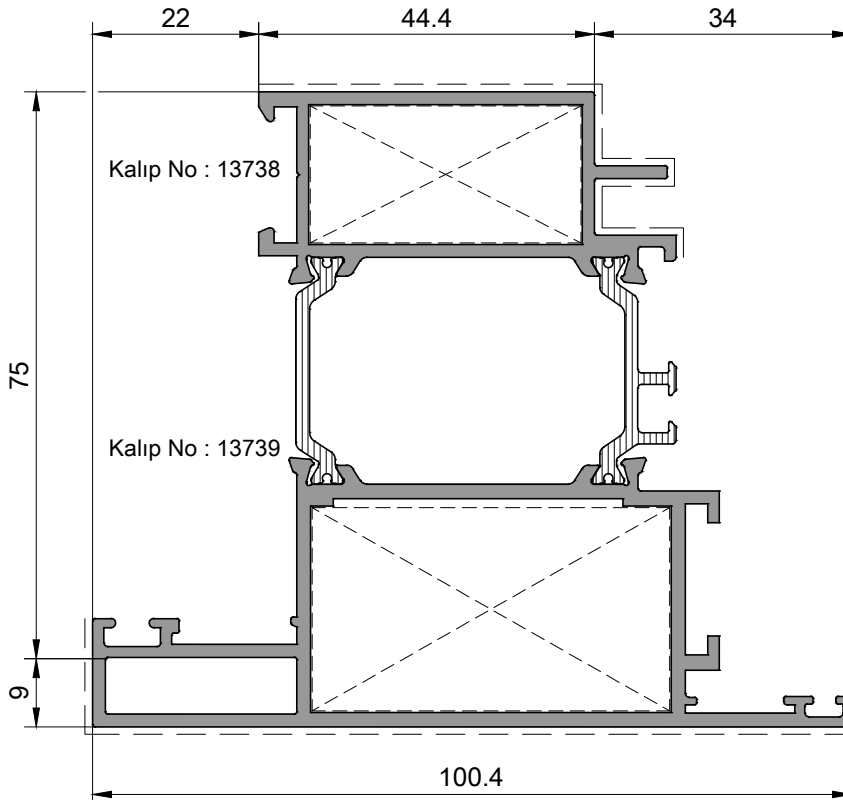

P 1184
Kanat Profili
Ağırlık : 2,385kg/mt

I_x : 61.09 cm⁴
 I_y : 48.82 cm⁴
 W_x : 11.68 cm³
 W_y : 9.76 cm³

P 1185

Çift Kanat Adaptör Profili

Ağırlık : 1,735kg/mt

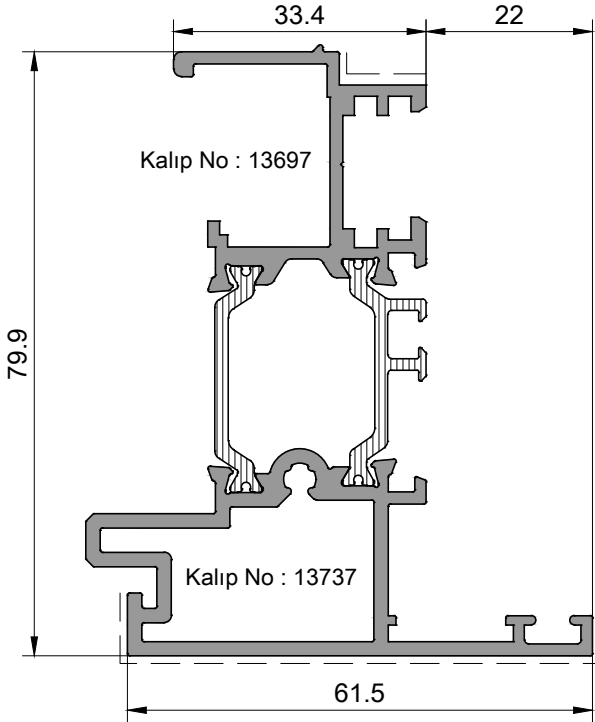

Ix : 35.31 cm⁴
Iy : 12.62 cm⁴
Wx : 9.31 cm³
Wy : 2.51 cm³

P 1176

Cam Çıtası

Ağırlık : 0,335kg/mt

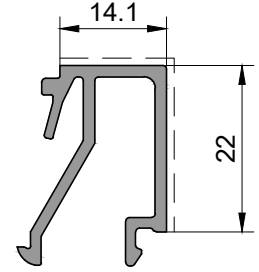

Kalıp No : 13698

P 1105

Cam Çıtası

Ağırlık : 0,360kg/mt

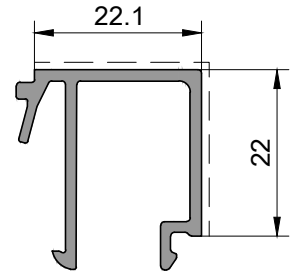

Kalıp No : 13113

P 1180

Cam Çıtası

Ağırlık : 0,380kg/mt

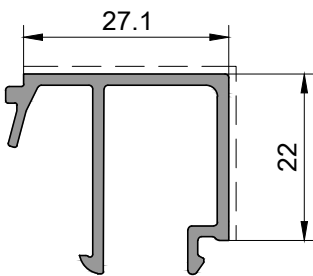

Kalıp No : 13670

P 1186

Cam Çıtası

Ağırlık : 0,260kg/mt

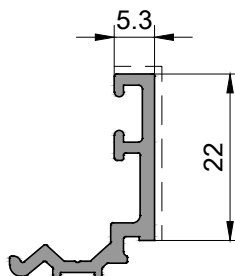

Kalıp No : 13740

P 1179

Cam Çıtası

Ağırlık : 0,350kg/mt

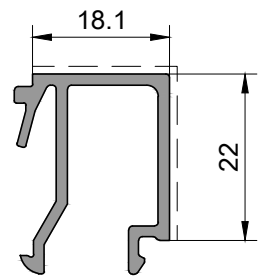

Kalıp No : 13671

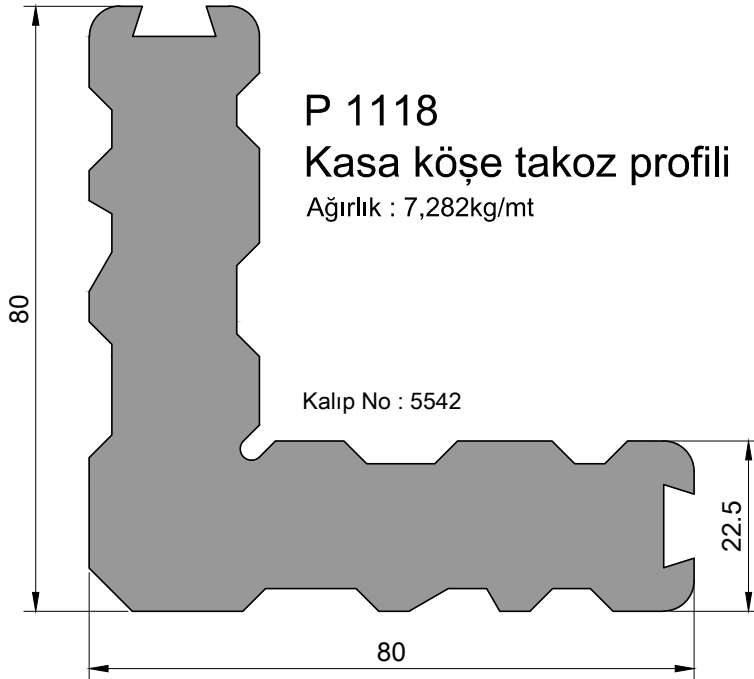
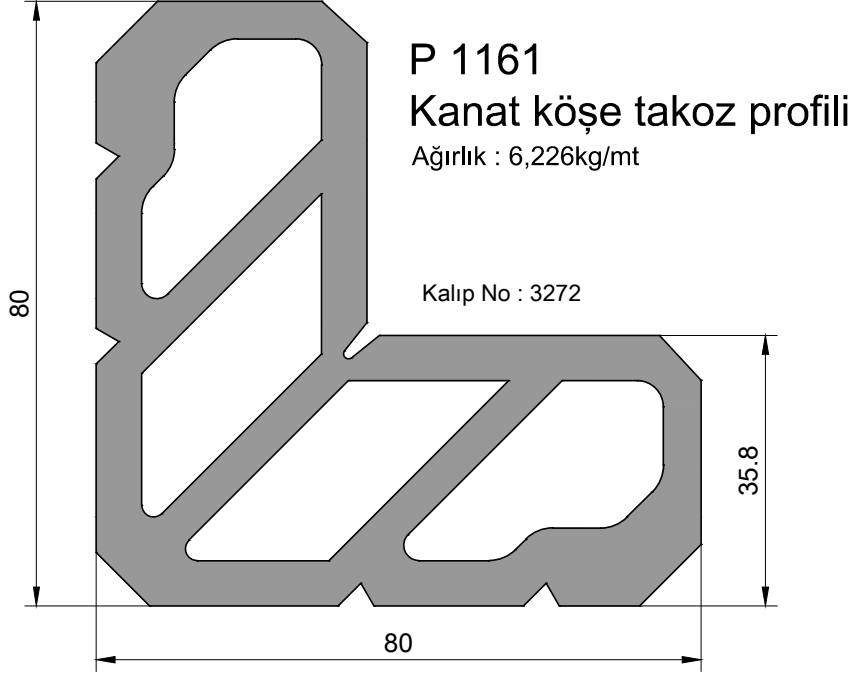

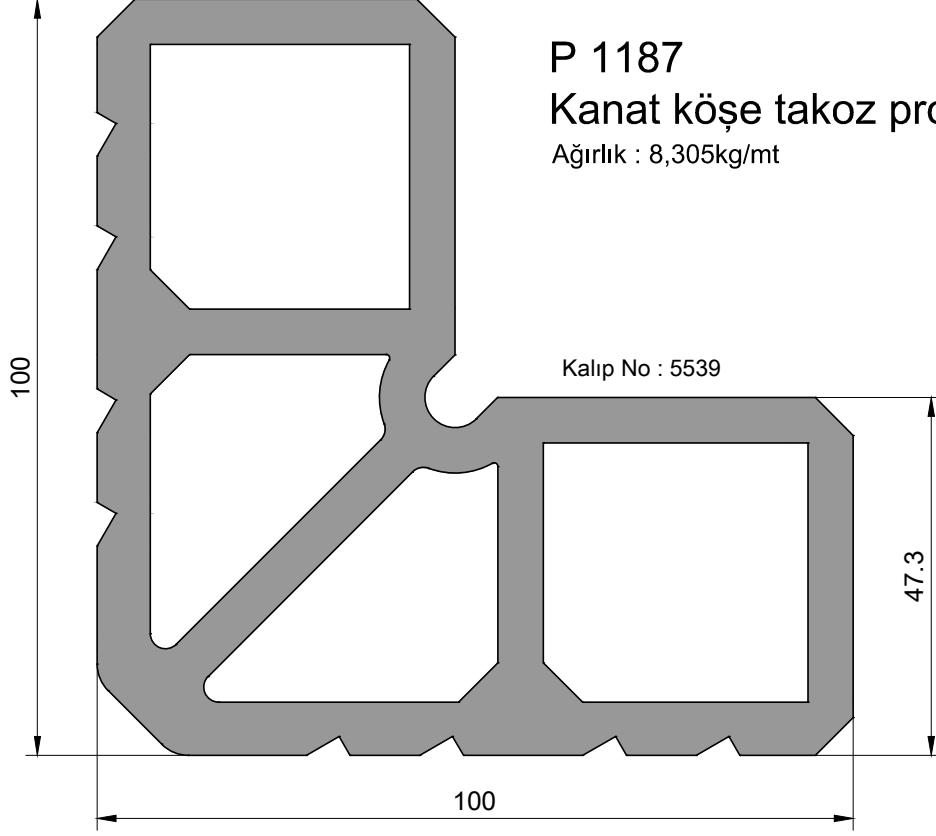

ICON 75D DIŐA AÇILIR KAPI SİSTEMİ

PRENSİP SİSTEM DETAYLARI

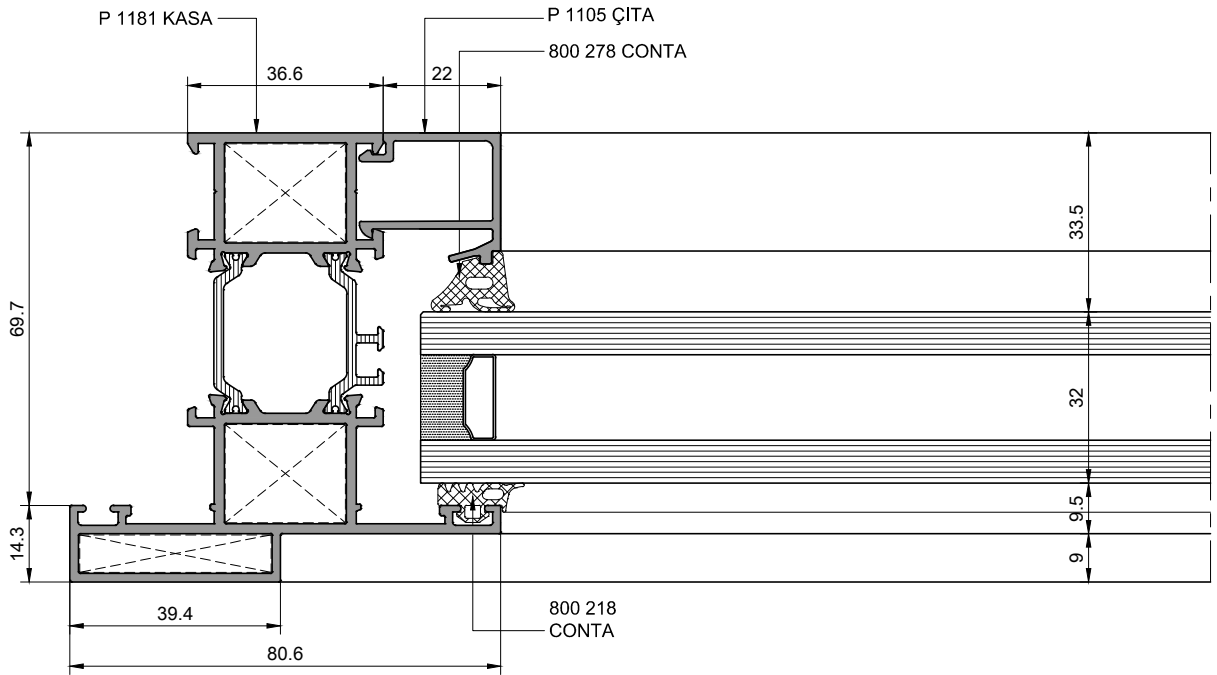
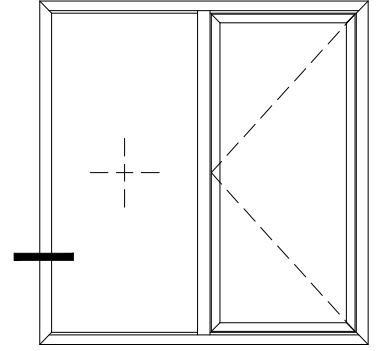

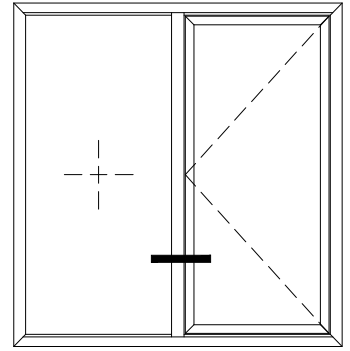

DIŞ GÖRÜNÜŞ

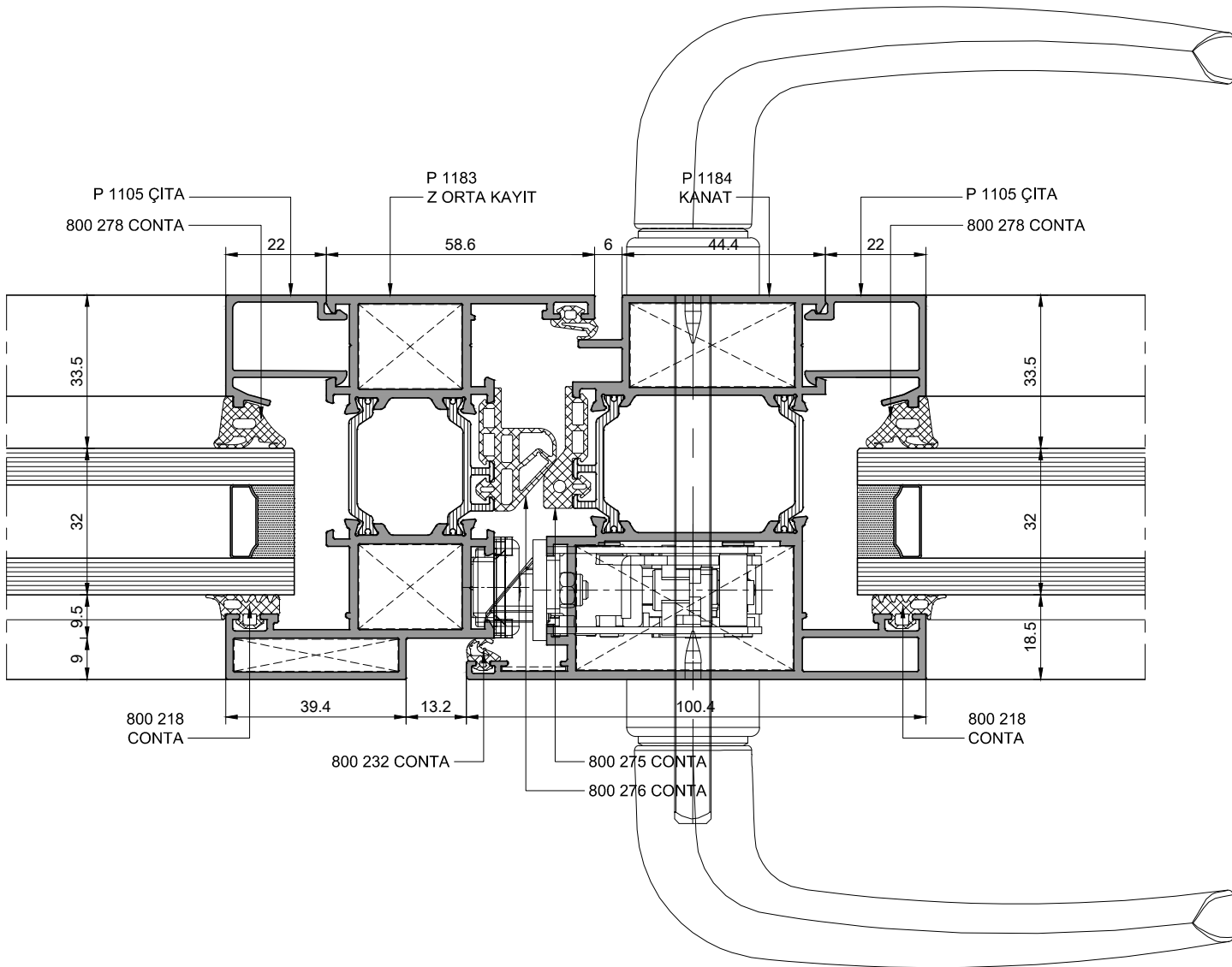

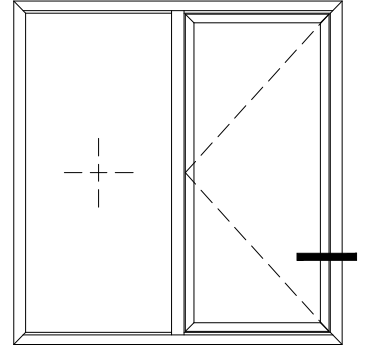

DIŞ GÖRÜNÜŞ

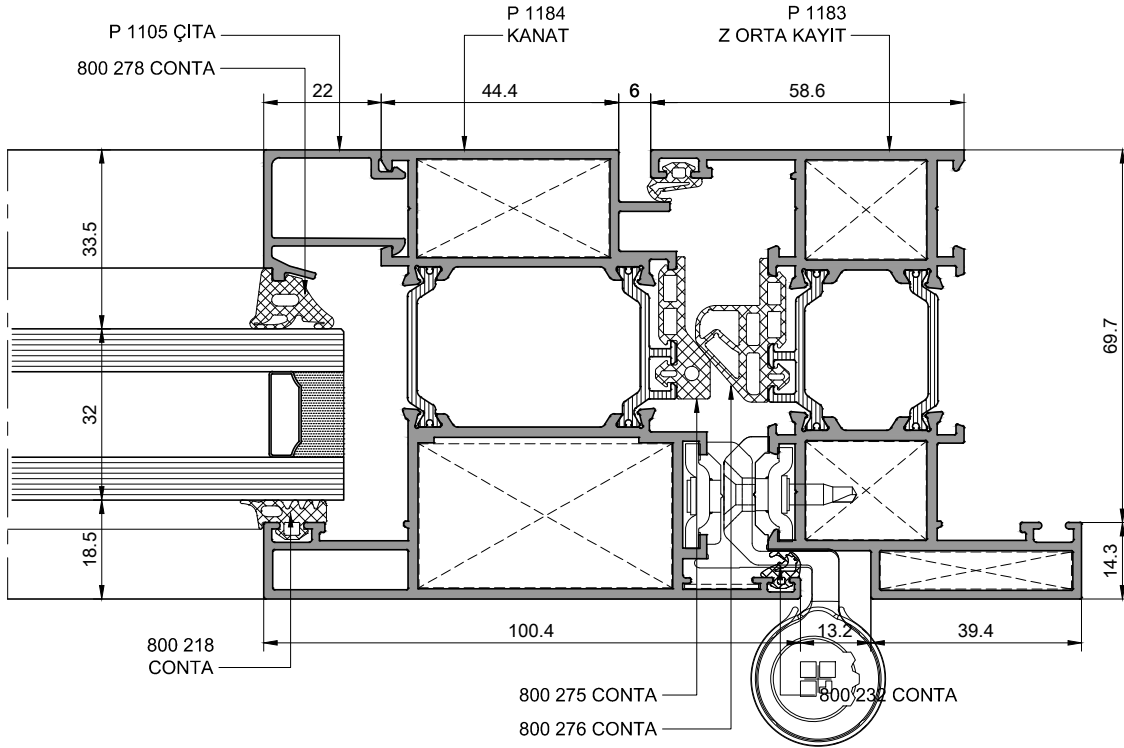

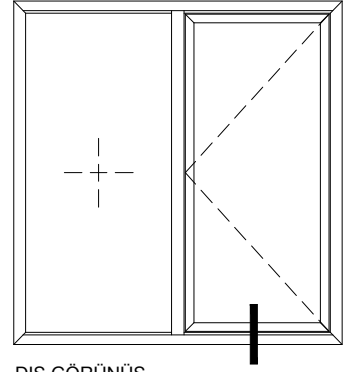

DIŞ GÖRÜNÜŞ

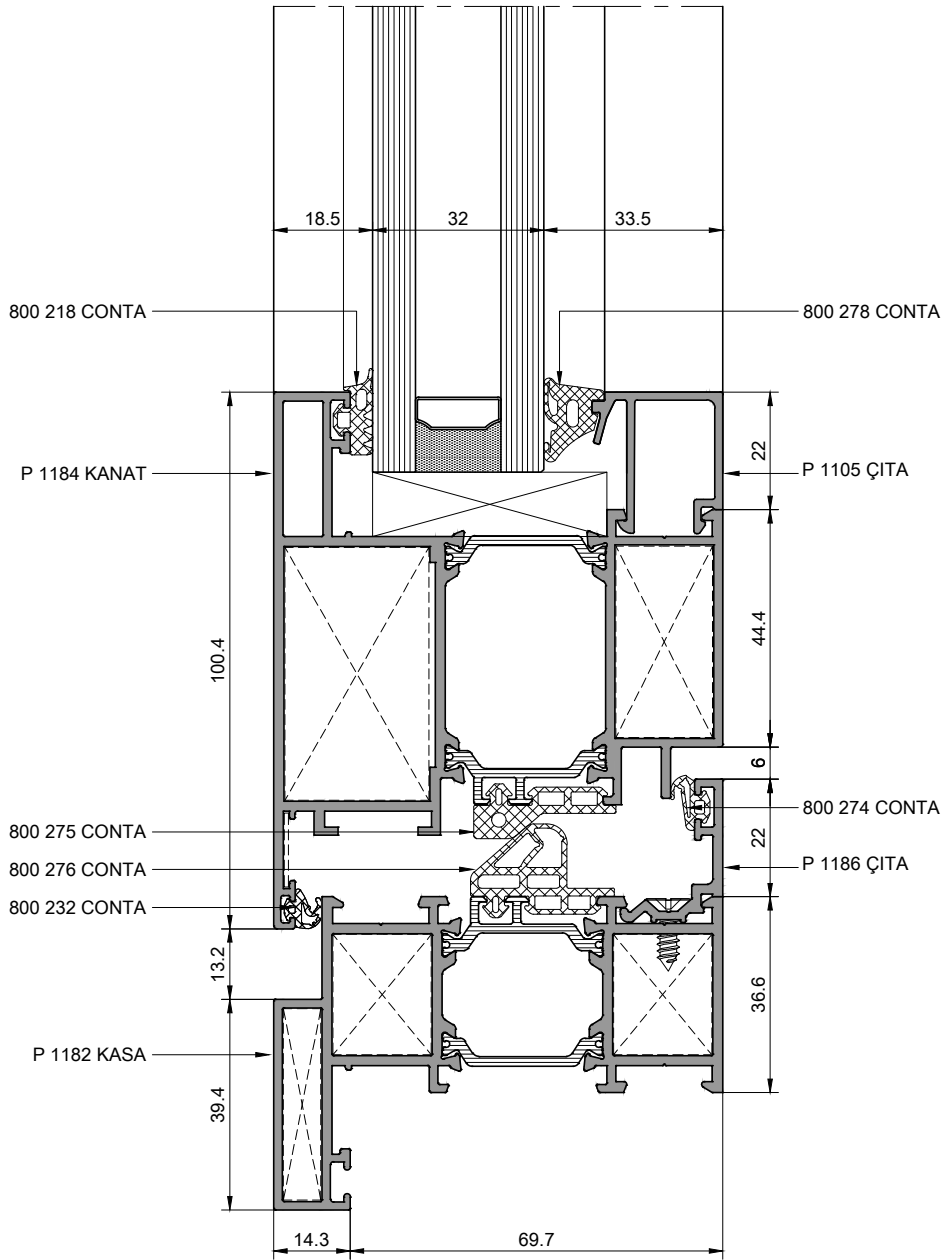

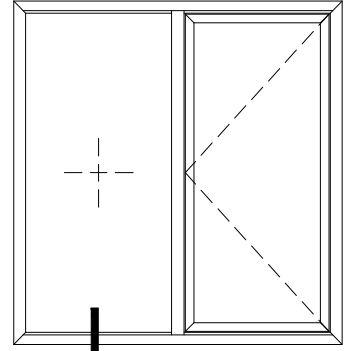

DIŞ GÖRÜNÜŞ

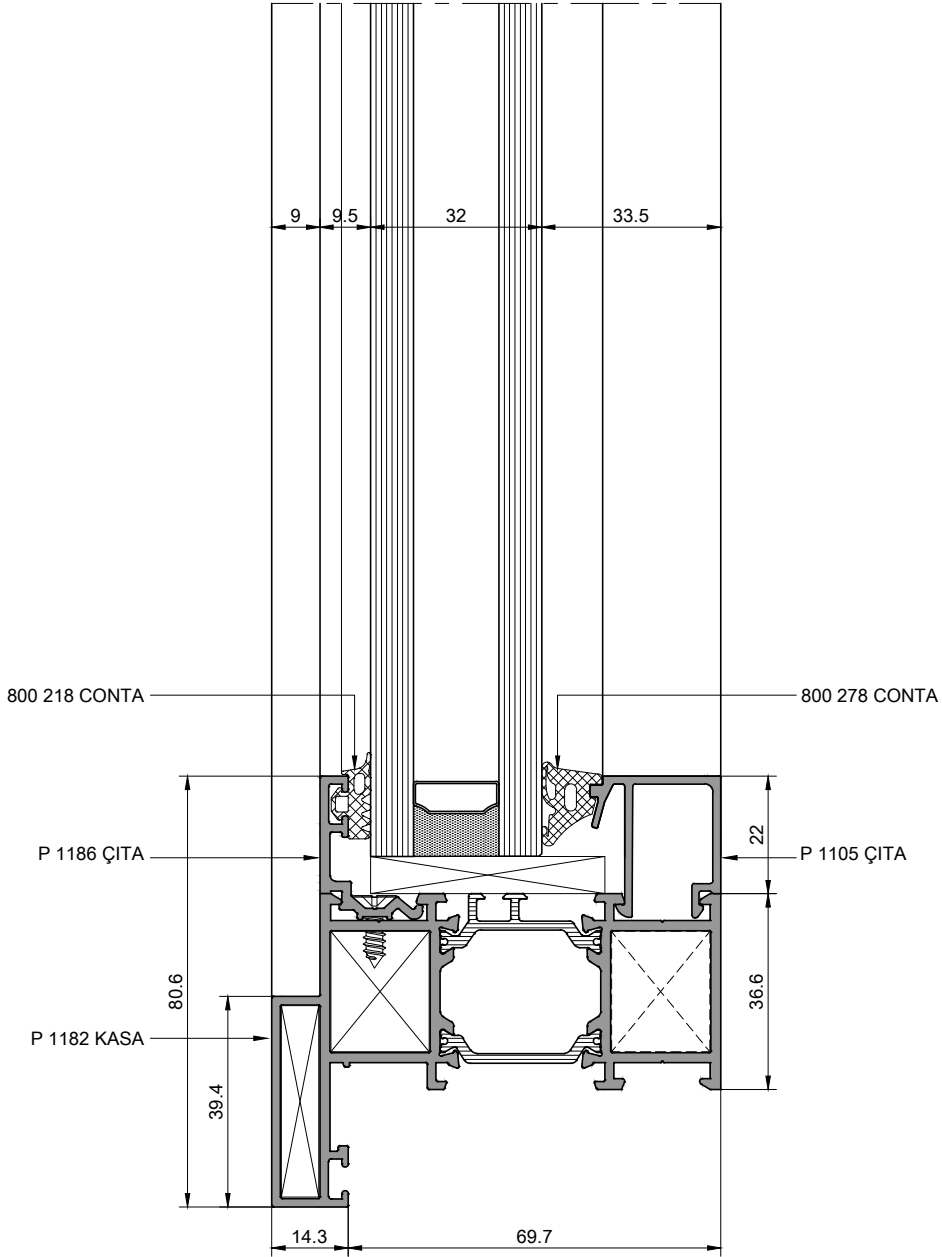

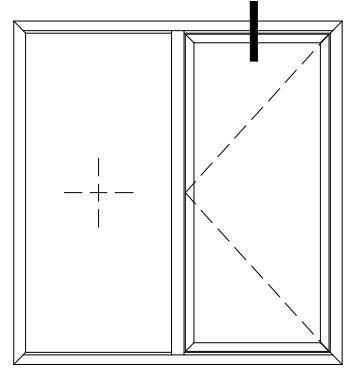
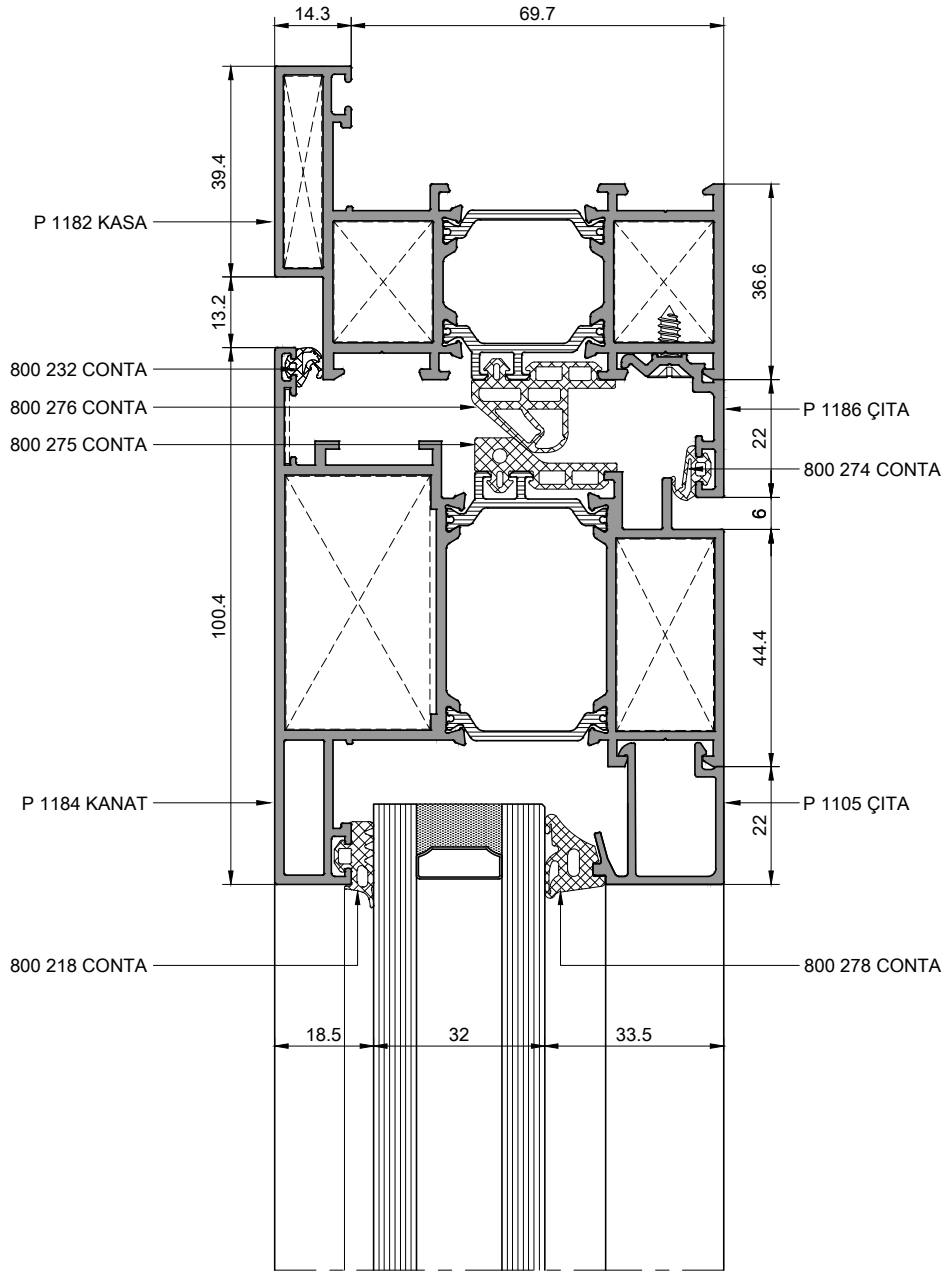

DIŞ GÖRÜNÜŞ

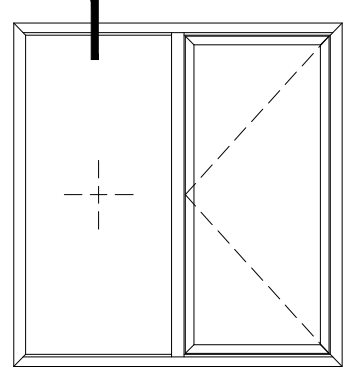
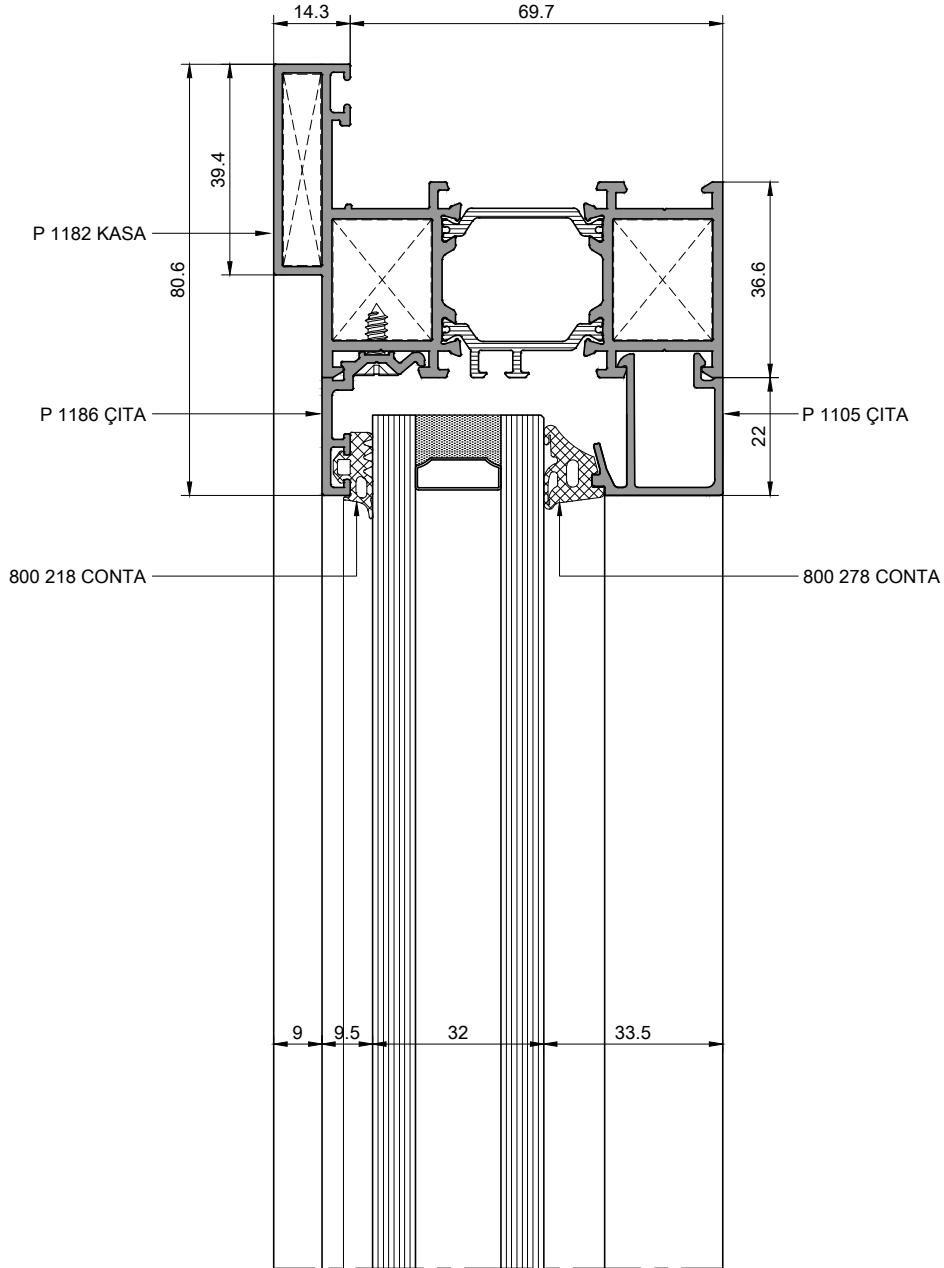

DIŞ GÖRÜNÜŞ

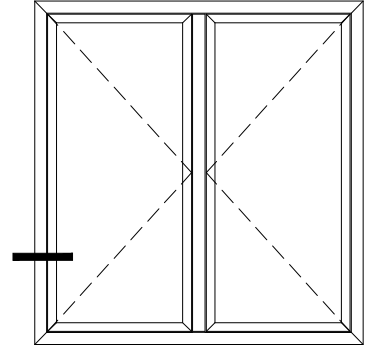

DIŞ GÖRÜNÜŞ

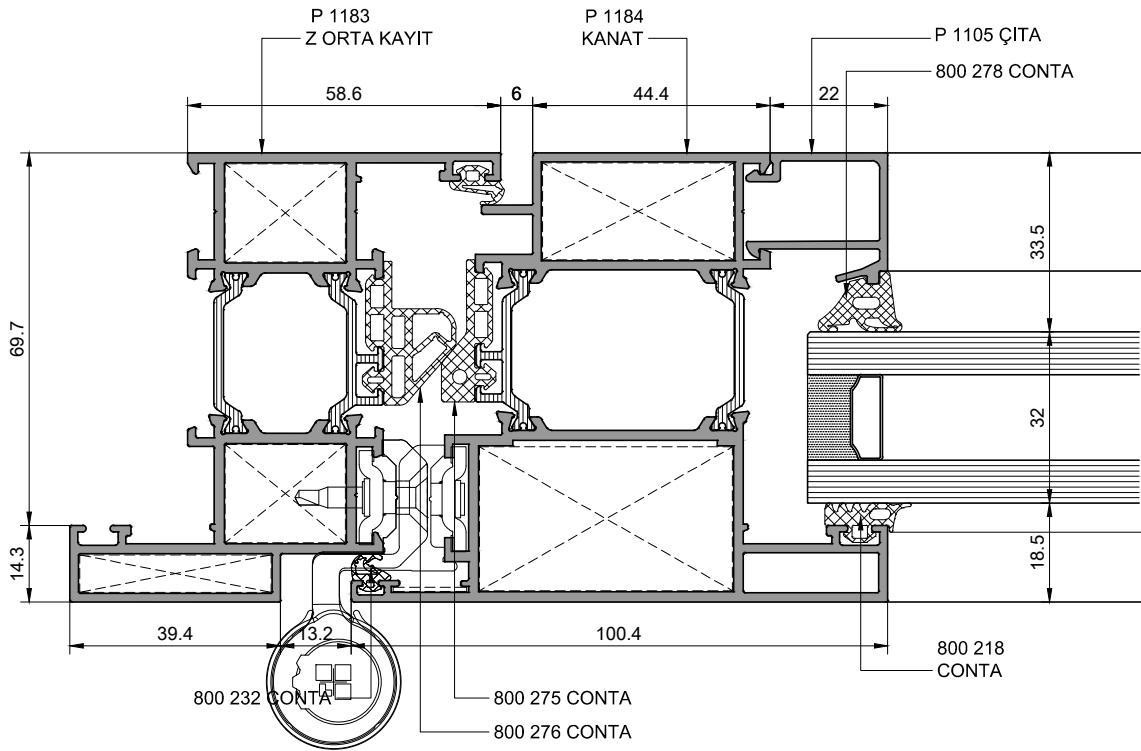

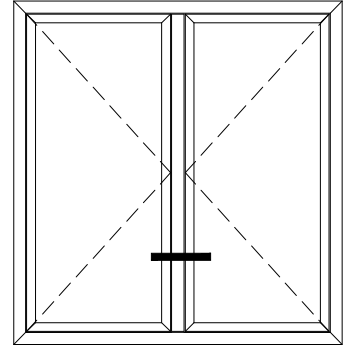

DIŞ GÖRÜNÜŞ

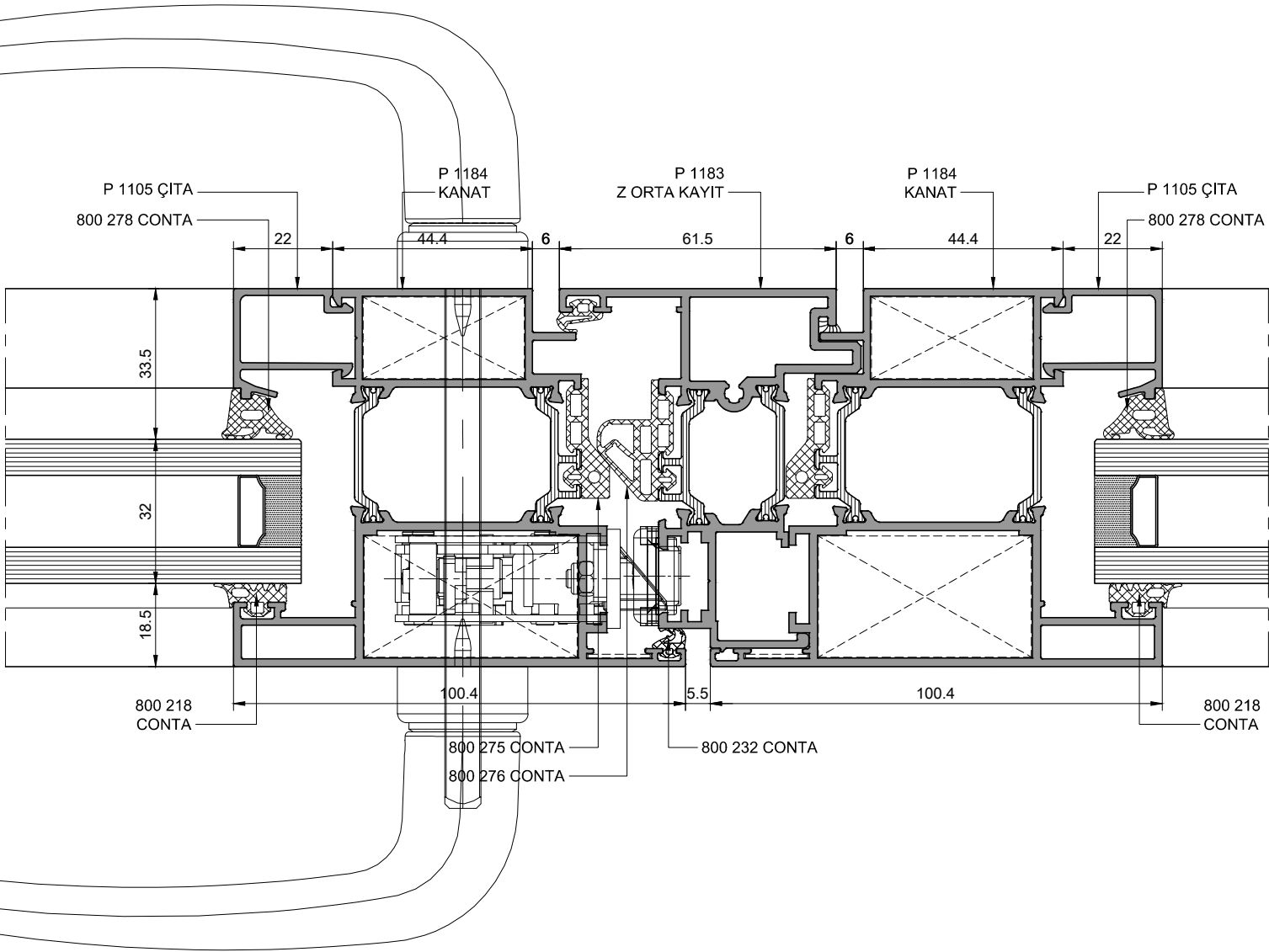

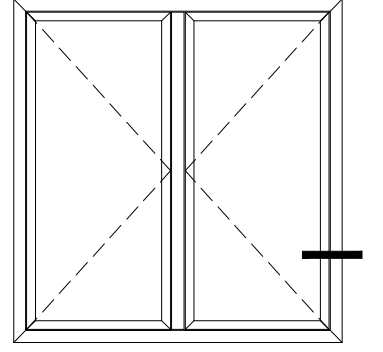

DIŞ GÖRÜNÜŞ

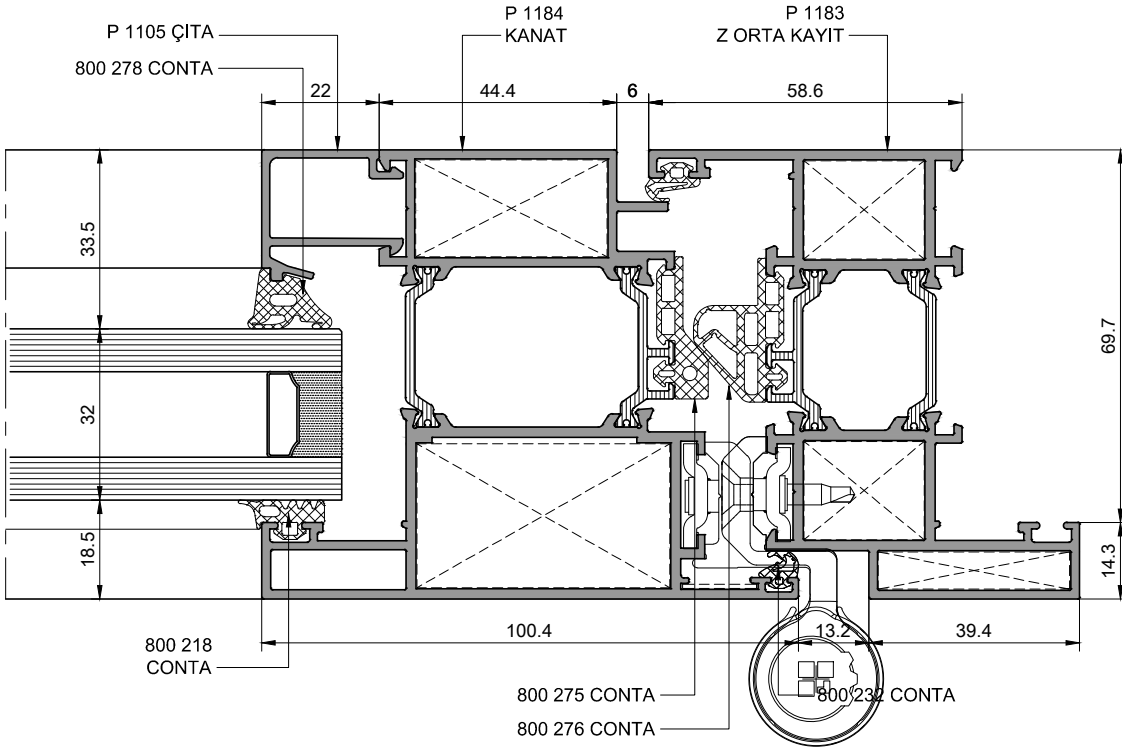

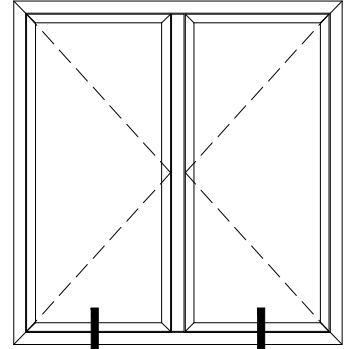

DIŞ GÖRÜNÜŞ

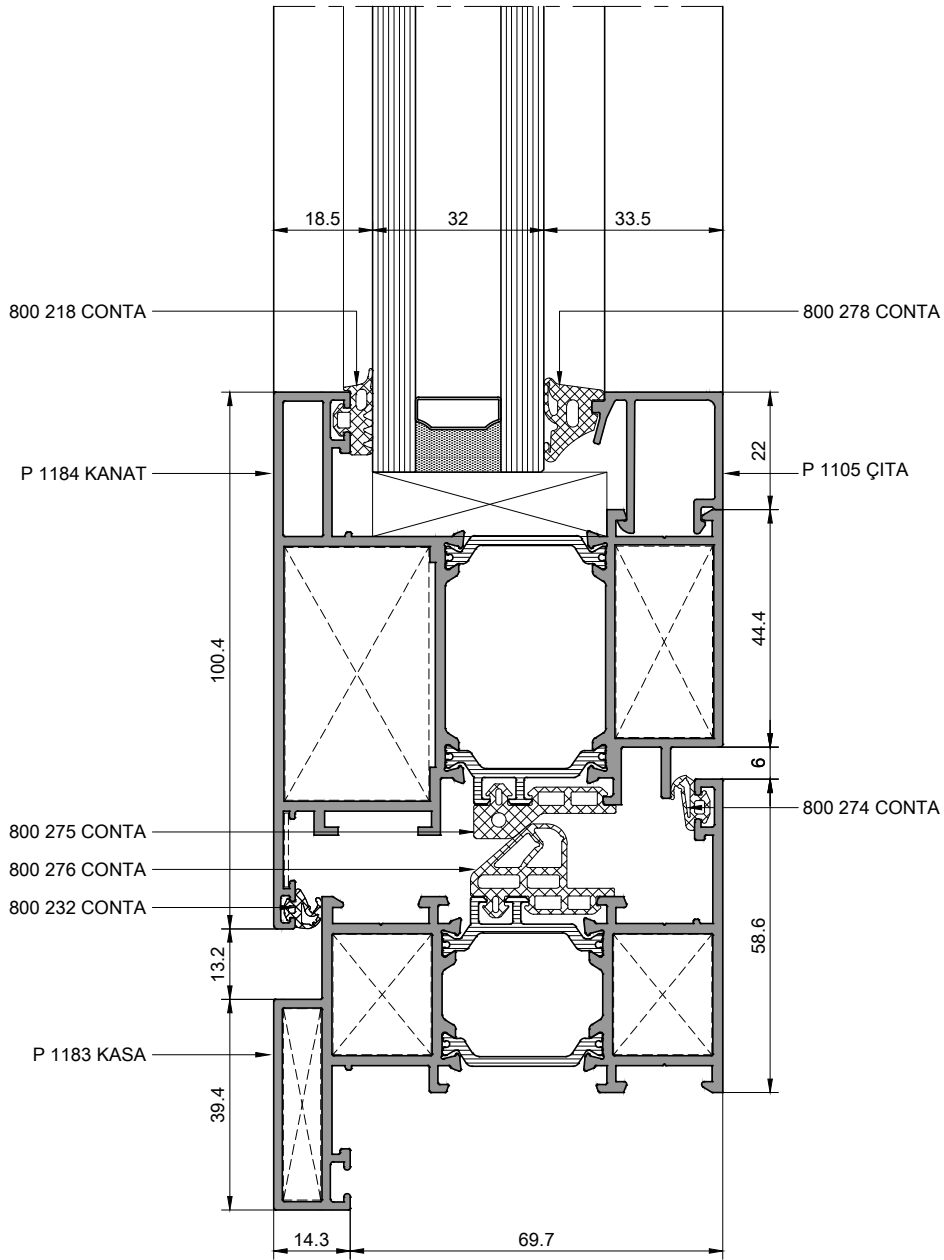

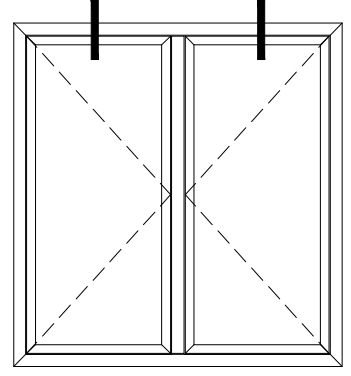

DIŞ GÖRÜNÜŞ

